



**ESM-9920 96 x 96 1/4 DIN
Temperature Controller with Universal Input**

- 4 digits process(PV) and 4 digits process set value(SV) display
- Universal process input (TC, RTD)
- Configurable ON/OFF, P, PI, PD and PID control forms
- Adaptation of PID Coefficients to the system with Self-Tune operation (Step Response Tuning)
- Programmable Heating or Cooling Functions for Control Output
- Alarm Functions for Alarm Output

Instruction manual of ESM-9920 Temperature Controller consists of two main sections. Explanation of these sections are below. Also, there are other sections which include order information and technical specifications of the device. All titles and page numbers in instruction manual are in "CONTENTS" section. User can reach to any title with section number.

Installation:

In this section, physical dimensions of the device, panel mounting, electrical wiring, physical and electrical installation of the device to the system are explained.

Operation and Parameters:

In this section user interface of the device, accessing to the parameters, description of the parameters are explained.

Also in these sections, there are warnings to prevent serious injury while doing the physical and electrical mounting or using the device.

Explanation of the symbols which are used in these sections are given below.



This symbol is used for safety warnings. User must pay attention to these warnings.



This symbol is used to determine the dangerous situations as a result of an electric shock. User must pay attention to these warnings definitely.



This symbol is used to determine the important notes about functions and usage of the device.

CONTENTS

1.PREFACE	Page	5
1.1 GENERAL SPECIFICATIONS		
1.2 ORDERING INFORMATION		
1.3 WARRANTY		
1.4 MAINTENANCE		
2.INSTALLATION	Page	8
2.1 GENERAL DESCRIPTION		
2.2 DIMENSIONS		
2.3 PANEL CUT-OUT		
2.4 ENVIRONMENTAL RATINGS		
2.5 PANEL MOUNTING		
2.6 INSTALLATION FIXING CLAMP		
2.7 REMOVING FROM THE PANEL		
3.ELECTRIAL WIRINGS	Page	13
3.1 TERMINAL LAYOUT AND CONNECTION INSTRUCTIONS		
3.2 ELECTRICAL WIRING DIAGRAM		
3.3 VIEW OF THE DEVICE LABEL		
3.4 SUPPLY VOLTAGE INPUT CONNECTION OF THE DEVICE		
3.5 PROCESS INPUT CONNECTION		
3.5.1 TC (THERMOCOUPLE) CONNECTION		
3.5.2 RTD CONNECTION		
3.6 GALVANIC ISOLATION TEST VALUES OF ESM-9920 TEMPERATURE CONTROLLER		
4.OUTPUT CONNECTION FORMS IN ESM-9920 TEMPERATURE CONTROLLER	Page	19
4.1 PROCESS OUTPUT (RELAY) CONNECTION		
4.2 PROCESS OUTPUT (SSR DRIVER) CONNECTION		
4.3 ALARM OUTPUT (RELAY) CONNECTION		
5.FRONT PANEL DEFINITION AND ACCESSING TO THE MENUS	Page	21
5.1 FRONT PANEL DEFINITION		
5.2 RUN THE DEVICE AND OBSERVATION OF SOFTWARE REVISION ON THE DISPLAYS		
5.3 ADJUSTMENT OF PROCESS SET VALUES		
5.4 ADJUSTMENT OF ALARM SET VALUES		
6.PARAMETERS	Page	24
6.1 PARAMETER LIST		
6.2 EASY ACCESS DIAGRAM OF PARAMETERS		
6.3 ENTERING TO THE PROGRAMMING SECTION AND PROCESS MENU		
6.4 CONTROL MENU		
6.5 ALARM MENU		
6.6 PROTECTION MENU		
7.GENERAL INFORMATION	Page	38
7.1 TUNE OPERATION		
7.2 ALARM TYPES		
8.FAILURE MESSAGES IN ESM-9920 TEMPERATURE CONTROLLER	Page	43
9.SPECIFICATIONS	Page	44

EU DECLARATION OF CONFORMITY

Manufacturer Company Name : Emko Elektronik A.S.

Manufacturer Company Address: DOSAB, Karanfil Sokak, No:6, 16369 Bursa, Turkiye

The manufacturer hereby declares that the product conforms to the following standards and conditions.

Product Name : Temperature Controller

Model Number : ESM-9920

Type Number : ESM-9920

Product Category : Electrical equipment for measurement, control and laboratory use

Conforms to the following directives :

73 / 23 / EEC The Low Voltage Directive as amended by 93 / 68 / EEC

89 / 336 / EEC The Electromagnetic Compatibility Directive

Has been designed and manufactured according to the following specifications

EN 61000-6-4:2001 EMC Generic Emission Standard for the Industrial Environment

EN 61000-6-2:2001 EMC Generic Immunity Standard for the Industrial Environment

EN 61010-1:2001 Safety Requirements for electrical equipment for measurement, control and laboratory use

1.Preface

ESM-9920 series temperature controllers are designed for measuring and controlling a process value. They can be used in many applications with their universal process input, control outputs and selectable alarm functions.

Some application fields which they are used are below:

<u>Application Fields</u>	<u>Application</u>
Glass	PID Process Control
Plastic	
Petro-Chemistry	
Textile	
Automotive	
Machine production industries	

1.1 General Specifications

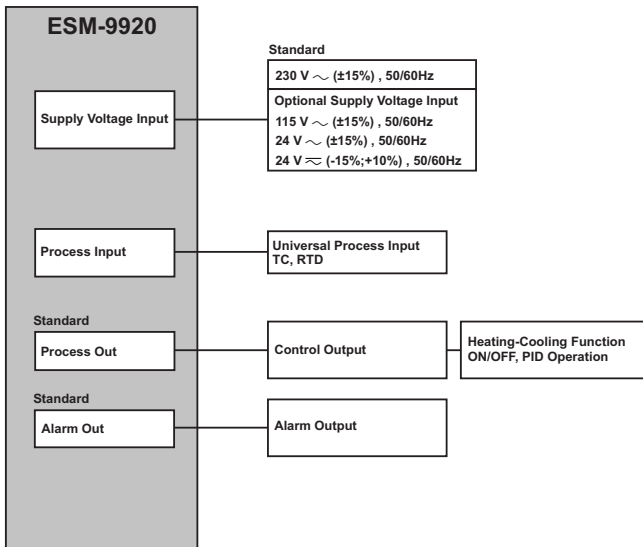

1.2 Ordering Information

ESM-9920 (REV06 14DIN)

A	BC	D	E	/	FG	HI	/	U	V	W	Z
		0	/	01	00	/	0	0	0		

A Supply Voltage
2 24V \sim (-15%;+10%) 50/60Hz
3 24V \sim (\pm 15%) 50/60Hz
4 115V \sim (\pm 15%) 50/60Hz
5 230V \sim (\pm 15%) 50/60Hz
9 Customer

BC Input Type
20 Configurable(Table-1)

D Serial Communication
0 None

E Process Output
1 Relay Output (5A@250V \sim at resistive load, 1 NO + 1NC)
2 SSR Driver Output (Maximum 12V \equiv , 10mA)

FG Alarm Output
01 Relay Output (5A@250V \sim at resistive load, 1 NO + 1NC)

(Table-1)

BC Input Type(TC)	Scale(°C)	Scale(°F)
23 J ,Fe CuNi IEC584.1(ITS90)	-200°C,900°C	-328°F,1652°F
25 K ,NiCr Ni IEC584.1(ITS90)	-200°C,1300°C	-328°F,2372°F
27 R ,Pt13%Rh Pt IEC584.1(ITS90)	0°C,1700°C	32°F,3092°F
28 S ,Pt10%Rh Pt IEC584.1(ITS90)	0°C,1700°C	32°F,3092°F
29 T ,Cu CuNi IEC584.1(ITS90)	-200°C,400°C	-328°F,752°F

BC Input Type(RTD)	Scale(°C)	Scale(°F)
39 PT 100 , IEC751(ITS90)	-200°C,650°C	-328°F,1202°F
40 PT 100 , IEC751(ITS90)	-199.9°C,650.0°C	-199.9°F,999.9°F

All order information of ESM-9920 Temperature Controller are given on the table at left. User may form appropriate device configuration from information and codes that at the table and convert it to the ordering codes.

Firstly, supply voltage then other specifications must be determined. Please fill the order code blanks according to your needs.

Please contact us, if your needs are out of the standards.



\sim \Rightarrow Vac,

\equiv \Rightarrow Vdc

\sim \Rightarrow Vdc or Vac can be applied.

1.3 Warranty

EMKO Elektronik warrants that the equipment delivered is free from defects in material and workmanship. This warranty is provided for a period of two years. The warranty period starts from the delivery date. This warranty is in force if duty and responsibilities which are determined in warranty document and instruction manual performs by the customer completely.

1.4 Maintenance

Repairs should only be performed by trained and specialized personnel. Cut power to the device before accessing internal parts.

Do not clean the case with hydrocarbon-based solvents (Petrol, Trichlorethylene etc.). Use of these solvents can reduce the mechanical reliability of the device. Use a cloth dampened in ethyl alcohol or water to clean the external plastic case.

2.Installation



Before beginning installation of this product, please read the instruction manual and warnings below carefully.

In package ,

- One piece unit
- Two pieces mounting clamp
- One piece instruction manual

A visual inspection of this product for possible damage occurred during shipment is recommended before installation. It is your responsibility to ensure that qualified mechanical and electrical technicians install this product.

If there is danger of serious accident resulting from a failure or defect in this unit, power off the system and separate the electrical connection of the device from the system.

The unit is normally supplied without a power switch or a fuse. Use power switch and fuse as required.

Be sure to use the rated power supply voltage to protect the unit against damage and to prevent failure.

Keep the power off until all of the wiring is completed so that electric shock and trouble with the unit can be prevented.

Never attempt to disassemble, modify or repair this unit. Tampering with the unit may result in malfunction, electric shock or fire.

Do not use the unit in combustible or explosive gaseous atmospheres.

During the equipment is putted in hole on the metal panel while mechanical installation some metal burrs can cause injury on hands, you must be careful.

Montage of the product on a system must be done with it's mounting clamp. Do not do the montage of the device with inappropriate mounting clamp. Be sure that device will not fall while doing the montage.

It is your responsibility if this equipment is used in a manner not specified in this instruction manual.

2.1 General Description

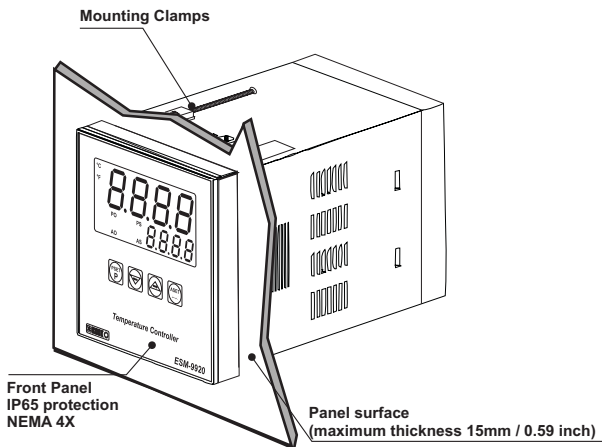

2.2 Dimensions

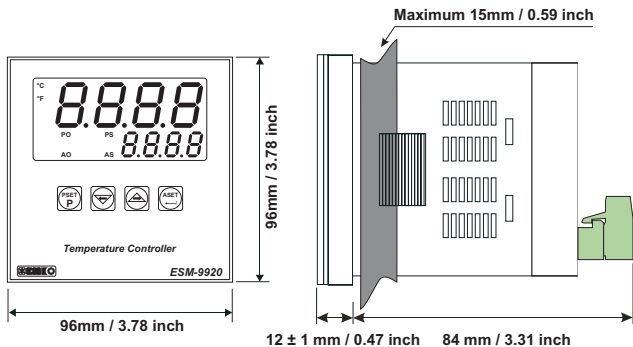

2.3 Panel Cut-Out

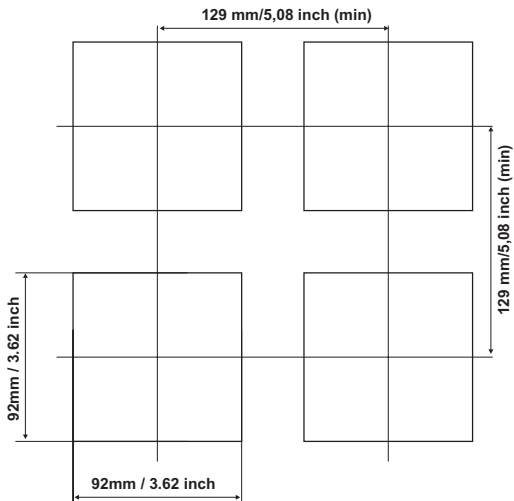

2.4 Environmental Ratings

Operating Conditions



Operating Temperature : 0 to 50 °C



Max. Operating Humidity : 90% Rh (non-condensing)



Altitude : Up to 2000m.



Forbidden Conditions:

Corrosive atmosphere

Explosive atmosphere

Home applications (The unit is only for industrial applications)

2.5 Panel Mounting

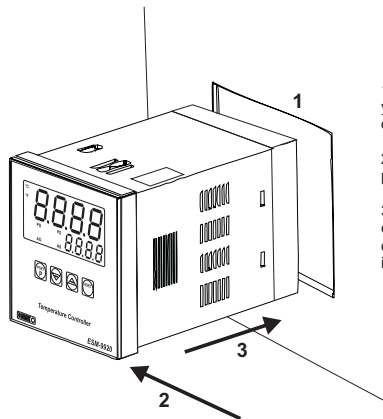

1-Before mounting the device in your panel, make sure that the cut-out is of the right size.

2-Check front panel gasket position

3-Insert the device through the cut-out. If the mounting clamps are on the unit, put out them before inserting the unit to the panel.



During installation into a metal panel, care should be taken to avoid injury from metal burrs which might be present. The equipment can loosen from vibration and become dislodged if installation parts are not properly tightened. These precautions for the safety of the person who does the panel mounting.

2.6 Installation Fixing Clamp

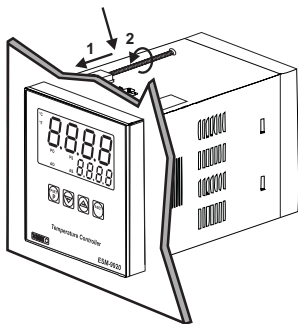

The unit is designed for panel mounting.

1-Insert the unit in the panel cut-out from the front side.

2- Insert the mounting clamps to the holes that located top and bottom sides of device and screw up the fixing screws until the unit completely immobile within the panel



Montage of the unit to a system must be done with it's own fixing clamps. Do not do the montage of the device with inappropriate fixing clamps. Be sure that device will not fall while doing the montage.

2.7 Removing from the Panel



Before starting to remove the unit from panel, power off the unit and the related system.

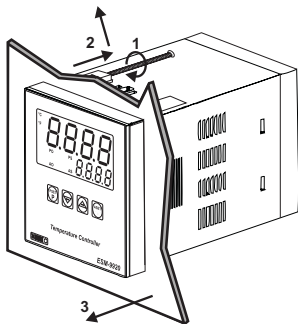

1-Loosen the screws.

2-Pull mounting clamps from top and bottom fixing sockets.

3-Pull the unit through the front side of the panel

3. Electrical Wirings



You must ensure that the device is correctly configured for your application. Incorrect configuration could result in damage to the process being controlled, and/or personal injury. It is your responsibility, as the installer, to ensure that the configuration is correct.

Parameters of the device has factory default values. These parameters must be set according to the system's needs.



Only qualified personnel and technicians should work on this equipment. This equipment contains internal circuits with voltage dangerous to human life. There is severe danger for human life in the case of unauthorized intervention.



Be sure to use the rated power supply voltage to protect the unit against damage and to prevent failure.



Keep the power off until all of the wiring is completed so that electric shock and trouble with the unit can be prevented.

3.1 Terminal Layout and Connection Instructions

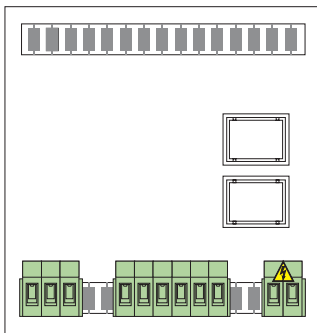

Max. 2.5mm / 0.098 inch
Wire Size:
14AWG/1mm²
Solid /Stranded



Torque 0.5 Nm



Screw driver 0.8x3mm



3.2 Electrical Wiring Diagram



Electrical wiring of the device must be the same as 'Electrical Wiring Diagram' below to prevent damage to the process being controlled and personnel injury.

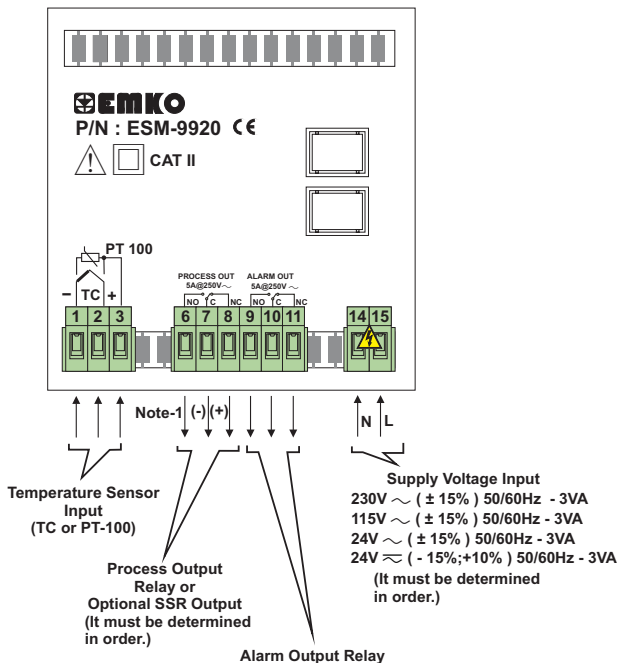

Note-1: Max 12V $\overline{\text{---}}$, 10mA for SSR Driver Output



Temperature measurement input is in CAT II class.

3.3 View of the Device Label

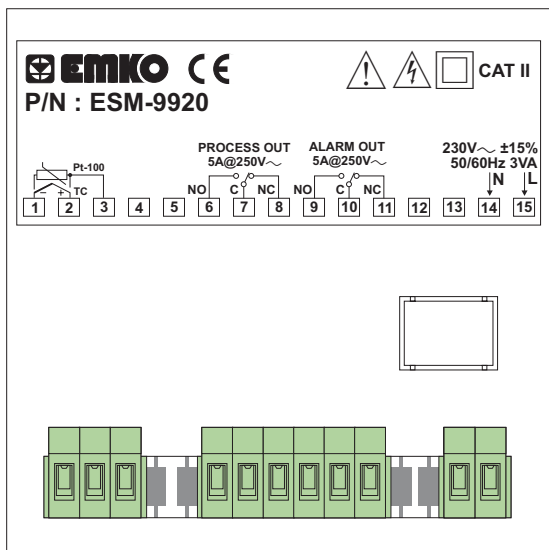

3.4 Supply Voltage Input Connection of the Device

Connection of Supply Voltage Input

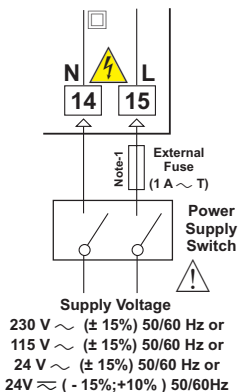

Note-1: External Fuse is recommended.



Make sure that the power supply voltage is the same indicated on the instrument.

Switch on the power supply only after that all the electrical connections have been completed.



Supply voltage range must be determined in order. Device is produced different for low and high voltage. While installing the unit, supply voltage range must be controlled and appropriate supply voltage must be applied to the unit. Controlling prevents damages in unit and system and possible accidents as a result of incorrect supply voltage.



There is no power supply switch or fuse on the device. So the user must put power supply switch and a fuse to the supply voltage input. In accordance with the safety regulations, the power supply switch shall bring the identification of the relevant instrument. Power supply switch and fuse must be put to a place where user can reach easily.



Power supply switch must be two poled for separating phase and neutral. On/Off condition of power supply switch is very important in electrical connection. On/Off condition of power supply switch must be signed for preventing the wrong connection.



External fuse must be on phase connection in ~ supply input.

External fuse must be on (+) line connection in = supply input.

3.5 Process Input Connection

3.5.1 TC (Thermocouple) Connection

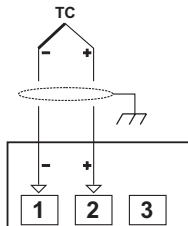

Connect the wires with the polarity as shown in the figure at left.



Always use compensation wire corresponding to the thermocouple used. If present, the shield must be connected to a proper ground.



Input resistance is greater than 10M Ω .

3.5.2 RTD Connection

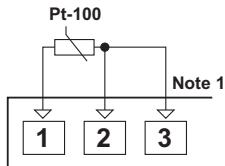

3-wire Pt-100 connection
(with line compensation)
(Max. Line impedance is 10 Ω)

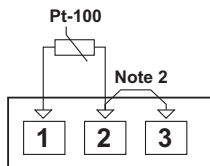

2-wire Pt-100 connection
(without line compensation)

Note 1 : In 3-wire system, use always cables of the same diameter (min 1mm²) Always use wires of the same gauge and type whether a 2-wire or 3-wire system.

Note 2 : Install a jumper between terminals 2 and 3 when using a 2-wire RTD.

Note 3 : If the distance is longer than 10 meters, use 3-wire system



Input resistance is greater than 10M Ω .

3.6 Galvanic Isolation Test Values of ESM-9920 Temperature Controller

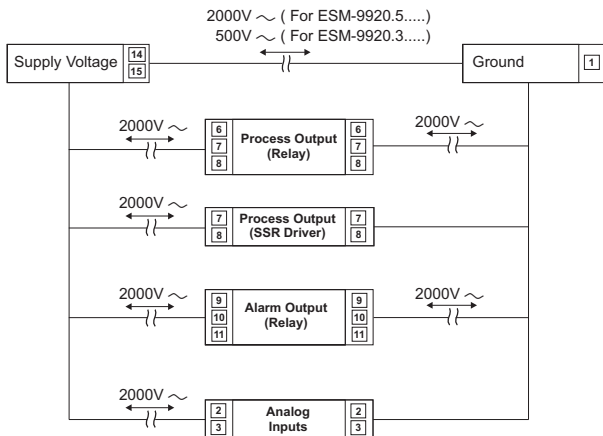

4. Output Connection Forms in ESM-9920 Temperature Controller

4.1 Process Output (Relay) Connection

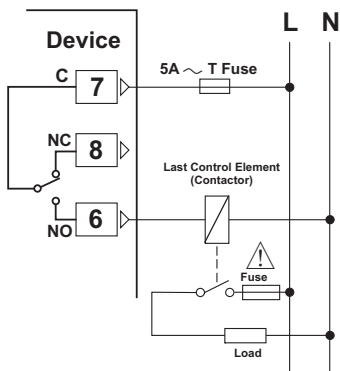

Fuses must be selected according to the application.

4.2 Process Output (SSR Driver) Connection

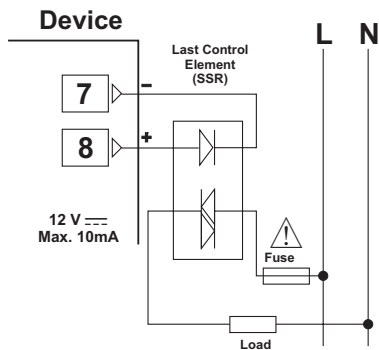

Fuses must be selected according to the application.

4.3 Alarm Output (Relay) Connection

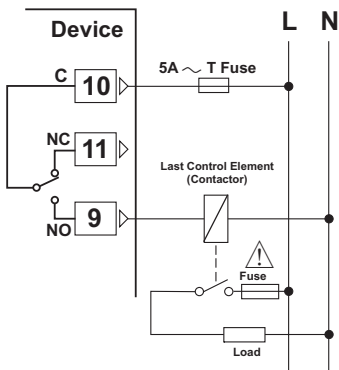

Fuses must be selected according to the application.

5. Front Panel Definition and Accessing to the Menus

5.1 Front Panel Definition

LED indication of °C:Centigrade Unit

LED indication of °F
Fahrenheit Unit

Process Output Status
Led

Alarm Output Status
Led

PS , Process Set
Value LED
AS , Alarm Set
Value LED



Displays
Process Value (PV)
and Parameter

Displays Set Value,
Parameter

Please refer to Section 6.1
for detailed information;
Section 6.1 (Process and
Alarm Set Parameters)

This button is used to access
to the process set value. If it
is pressed for 5 seconds
continuously programming
section is entered.

This button is used to
access to the alarm set
value and use as OK
button.

Note-1

This button is used to
decrease the parameter
values, access to the
program menus

Note-1

This button is used to
increase the parameter
values and access to
the program menus

Note-1: If increment or decrement button is pressed for 5 seconds continuously, increment and decrement number become 10, if increment or decrement button is pressed for 10 seconds continuously, increment and decrement number become 100.

5.2 Run the Device and Observation of Software Version on the Displays

When the power is applied to the device all led indicators and display segments are momentarily illuminated for testing. Software revision number of the controller on the bottom display is momentarily illuminated.

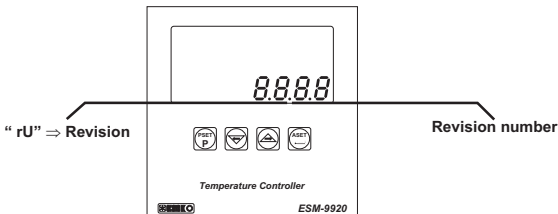

When power on, display of the indicator is like below:

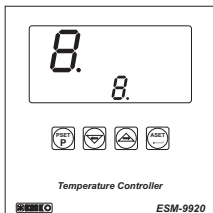

First segments of top and bottom displays are tested

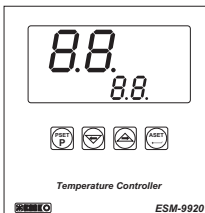

Second segments of top and bottom displays are tested.

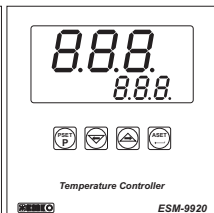

Third segments of top and bottom displays are tested.

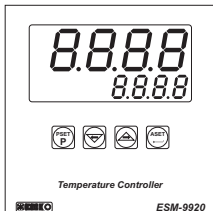

Fourth segments of top and bottom displays are tested.

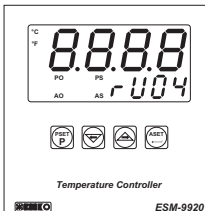

Revision number is shown. All leds are energised.

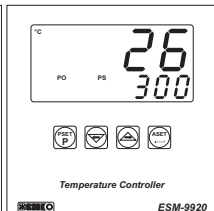

Main operation screen is shown



If there is an unexpected situation while opening the device, power off the device and inform a qualified personnel.

5.3 Adjustment of Process SET Values

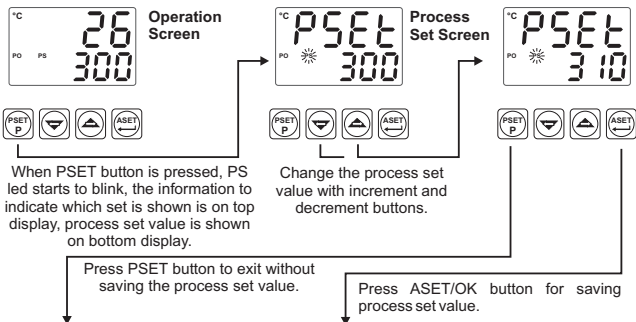

5.4 Adjustment of Alarm SET Values

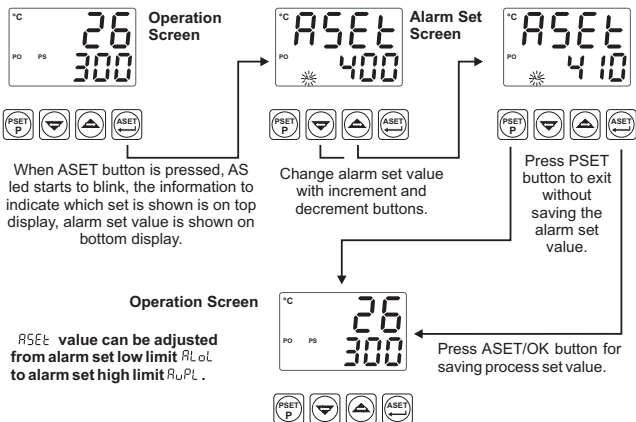

6. Parameters

6.1 Parameter List

PrOS Process menu title

PInS Process input type selection (**Default Value = J Type (FE.C.n)**)

FEEn J type (Fe,Cu,Ni) Thermocouple, -200°C,900°C or -328°F,1652°F

nEn K type (Ni,Cr,Ni) Thermocouple, -200°C,1300°C or -328°F,2372°F

P13r R type (Pt13%RhPt) Thermocouple, 0°C,1700°C or 32°F,3092°F

P10r S type (Pt10%RhPt) Thermocouple, 0°C,1700°C or 32°F,3092°F

CuEn T type (Cu,Cu,Ni) Thermocouple, -200°C,400°C or -328°F,752°F

rtD0 Pt-100, -200°C,650°C or -328°F,1202°F

rtD1 Pt-100, -199.9°C,650.0°C or -199.9°F,999.9°F

Unit Unit Selection (**Default Value = °C**)

oC Unit is °C

oF Unit is °F

PLoL Process Set Low Limit. Minimum process set value is defined with this parameter. It changes according to process input type and scale. (**Default Value = -200**)

PuPL Process Set High Limit. Maximum process set value is defined with this parameter. It changes according to process input type and scale. (**Default Value = 900**)

PuOf Display offset for process value. It can be adjusted from -10% of scale (PuPL-PLoL) to 10% of scale (PuPL-PLoL). It is added to the process display value. (**Default Value = 0**)

Cont Control menu title

PrTS Process Type selection (**Default Value = Heat**)

HEAT Process type is heating

COOL Process type is cooling

CnTS Process Control Type selection (**Default Value = on.oF**)

on.oF Process Control form is ON/OFF

Pid Process Control form is PID

tunE Tune parameter (**Default Value = no**)

This parameter can be observed if Cnts parameter is Pid

no Self - Tune (Step Response Tuning) does not run. (Please refer to Section 7.1 for Tune Operation)

YES Self - Tune runs (Step Response Tuning).

P_rb_n Proportional Band. It can be adjusted from 1.0% to 100.0%.
If Process Control Type selection "CntS" is "Pid", then this parameter can be observed. (Default Value = 10.0)

t_{int} Integral time.
It can be adjusted from 0 to 3600 seconds. If Process Control Type selection "CntS" is "Pid", then this parameter can be observed. (Default Value = 100)

t_{dEr} Derivative time. It can be adjusted from 0.0 to 999.9 seconds.
If Process Control Type selection "CntS" is "Pid", then this parameter can be observed. (Default Value = 25.0)

t_{Con} Output control period. It can be adjusted from 1 to 150 seconds.
If Process Control Type selection "CntS" is "Pid", then this parameter can be observed. (Default Value = 10)

HYS_t Hysteresis value.
If Process Control Type selection "CntS" is "on.oF", then this parameter can be observed. It can be adjusted from 0% of defined scale to 50% of defined scale.
(Defined Scale= PuPL- PLoL) (Default Value = 0)

AL_r Alarm menu title

AH_{St} Alarm Hysteresis value. It can be adjusted from 0% of defined scale to 50% of defined scale. (Defined scale = AuPL-ALoL) (Default Value = 0)

AT_{SL} Alarm Type selection (Default Value = PHA (Process High Alarm))

PH_A Process High Alarm

PLo_A Process Low Alarm

dH_A Deviation High Alarm

dLo_A Deviation Low Alarm

dbn_A Deviation Band Alarm

drn_A Deviation Range Alarm

ALoL Alarm Set Low Limit. It can be adjusted from Process Set Low Limit parameter value to Alarm Set High Limit parameter value.
It changes according to the process input type and scale. (Default Value = 0)

AuPL Alarm Set High Limit. It can be adjusted from Alarm Set Low Limit value to Process Set High Limit parameter value.
It changes according to the process input type and scale. (Default Value = 500)

Ao_{nt} Alarm on delay time . It can be adjusted from 0 to 9999 seconds.
(Default Value = 0)

Ao_{ft} Alarm off delay time. It can be adjusted from 0 to 9998 seconds.
When it is higher than 9998, "LtCH" is shown and alarm latching output is selected.
To make the alarm latching output passive, decrement button must be pressed in main operation screen (Default Value = 0)

Prot Protection menu title

P_rPS Password for accessing to the programming section. It can be adjusted from 0 to 9999. (Default Value = 0)

6.2 Easy Access Diagram of Parameters

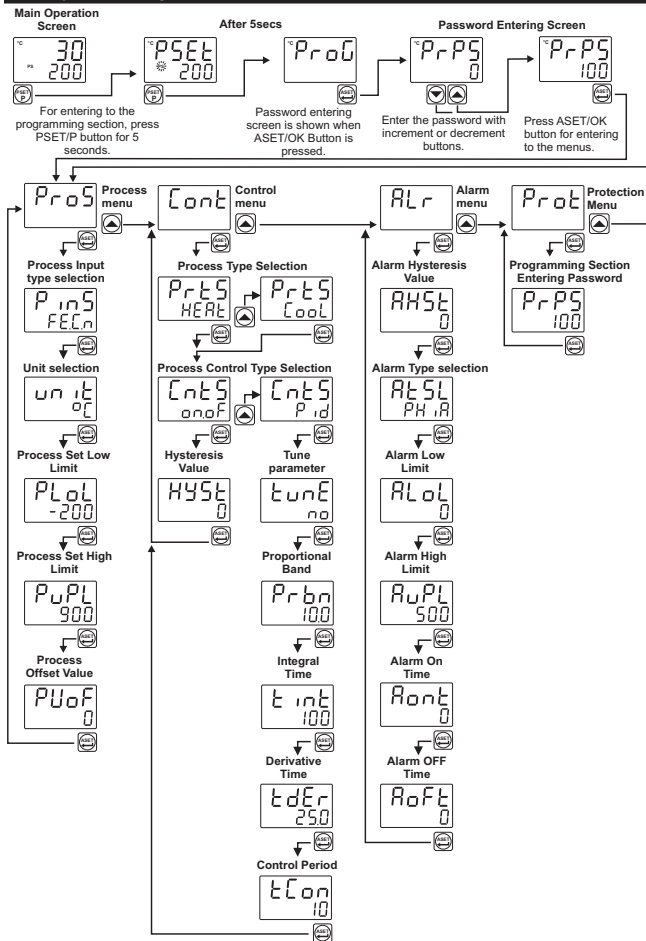

6.3 Entering to the Programming Section and Process Menu

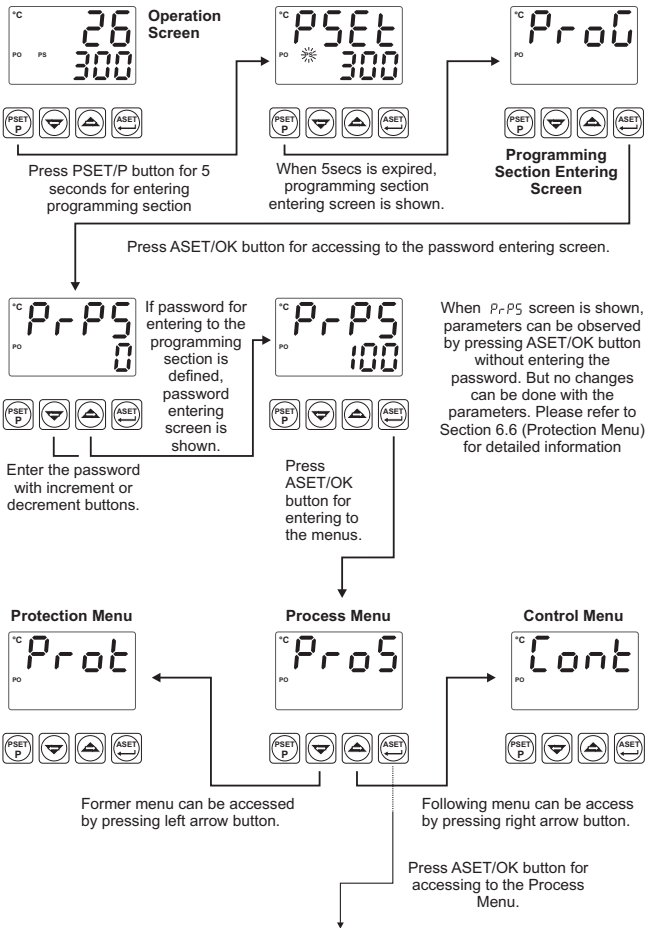

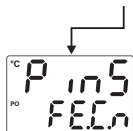

Process Input Type Selection

Process Input Type can be changed into any of the type which are listed below with increment and decrement buttons.

- FEEL: J type (Fe,Cu,Ni)Thermocouple, -200°C,900°C or -328°F,1652°F
- nEL: K type (Ni,Cr,Ni)Thermocouple, -200°C,1300°C or -328°F,2372°F
- P IEL: R type (Pt13%RhPt) Thermocouple, 0°C,1700°C or 32°F,3092°F
- P IEL: S type (Pt10%RhPt) Thermocouple, 0°C,1700°C or 32°F,3092°F
- EL: T type (Cu,Cu,Ni)Thermocouple, -200°C,400°C or -328°F,752°F
- EL: Pt - 100, -200°C,650.0°C or -328°F,1202°F
- EL: Pt - 100, -199.9°C,650.0°C or -199.9°F,999.9°F

Press ASET/OK button for saving the changes and accessing to the following parameter.

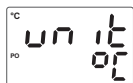

Unit selection

Unit can be selected °C or °F by increment and decrement buttons.



Press ASET/OK button for saving the changes and accessing to the following parameter.



Process Set Value Low Limit

Minimum value of the process set value can be adjusted with this parameter. It can be adjusted from process input type minimum value to process high limit parameter P_{uPL} value. It changes according to the process input type and scale.



Press ASET/OK button for saving the changes and accessing to the following parameter.



Process Set Value High Limit

Maximum value of the process set value can be adjusted with this parameter. It can be adjusted from process low limit parameter P_{LoL} to process input type maximum value. It changes according to the process input type and scale.



Press ASET/OK button for saving the changes and accessing to the following parameter.

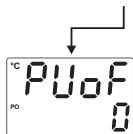

Process Value Display Offset

It can be adjusted -10% of scale (PuPL-PLoL) to 10% scale (PuPL-PLoL).
Defined value is added to the process display value.



Press ASET/OK button for saving the changes and accessing to the following parameter.

Operation Screen



Press PSET/P for exiting menu list and turn to operation screen.

Process Menu



Following menu can be access by pressing right arrow button.

Control Menu



6.4 Control Menu

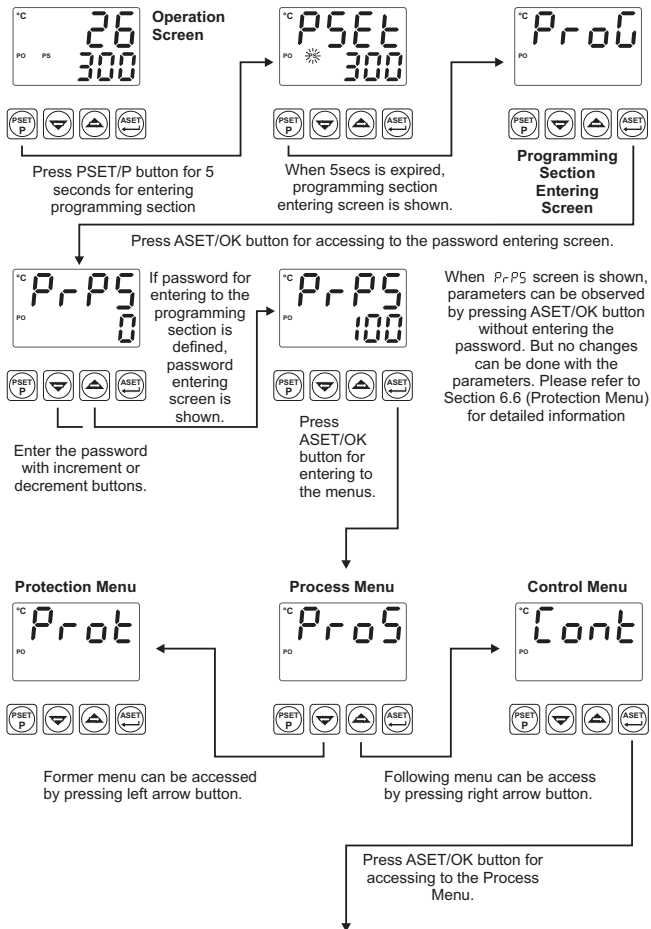



Process Type Selection

Process Type Selection can be selected *HEAT* or *COOL* with increment and decrement buttons.



Press ASET/OK button for saving the parameter and accessing to the next parameter.

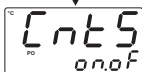

Process Control Type Selection

Process Control Type can be selected *onof* or *Pid* with increment and decrement buttons.

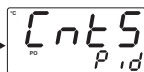

Press ASET/OK button for saving the parameter and accessing to the next parameter.



Press ASET/OK button for saving the parameter and accessing to the next parameter.

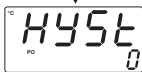

Hysteresis Value

If Process Control Type selection *Cnts* is *onof*. It can be adjusted from 0% of defined scale (*PuPL-PLoL*) to 50% of defined scale (*PuPL-PLoL*) with increment and decrement buttons.



Tune Parameter

Tune operation can be started and stopped with increment and decrement buttons. If Process Control Type *Cnts* is *Pid* Then this parameter can be observed.



If Process Control Type selection *Cnts* is *onof*, parameter is saved and exit from control menu by pressing ASET/OK button.

Press ASET/OK button for saving the parameter and accessing to the next parameter.



Control Menu



Proportional Band

Proportional band can be adjusted from 1.0% to 100.0% with increment and decrement buttons. If Process Control Type selection *Cnts* = *Pid*, then this parameter can be observed. For example;
If $P_{uPL} = 1000^{\circ}\text{C}$, $P_{LoL} = 0^{\circ}\text{C}$ and $P_{rbn} = 50.0$
Proportional Band = $(P_{uPL} - P_{LoL}) * P_{rbn} / 100.0$
Proportional Band = $(1000 - 0) * 50.0 / 100.0 = 500^{\circ}\text{C}$



Press ASET/OK button for saving the parameter and accessing to the next parameter.

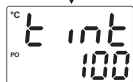

Integral Time

It can be adjusted from 0 to 3600 seconds with increment and decrement buttons. If Process Control Type selection $Ctrl5 = PID$, then this parameter can be observed.



Press ASET/OK button to save the value and access to the next parameter.

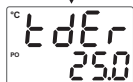

Derivative Time

It can be adjusted from 0.0 to 999.9 seconds.

If Process Control Type selection $Ctrl5 = PID$, then this parameter can be observed.



Press ASET/OK button for saving the parameter and accessing to the next parameter.

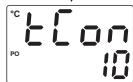

Output Control Period

It can be adjusted from 1 to 150 with increment and decrement buttons.

If Process Control Type selection $Ctrl5 = PID$, then this parameter can be observed.

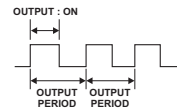

Press ASET/OK button for saving the parameter and accessing to the next parameter.

Relay Output : Output period must be short for stable process control. Relay must not be used in short output periods because of limited life of their relay contact (number of open/close events). Relay output must be used as control output in values near to 30 seconds or greater than this value.

SSR Output : If short output period is needed in a system (approximately 1-2 seconds), then using SSR driver as control output is recommended.

Process Menu



Control Menu



Alarm Menu

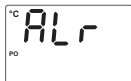

Former menu can be accessed by pressing left-arrow button.

Next menu can be accessed by pressing right-arrow button.

Press PSET/P button to exit from menu list and turn to the operation screen.

6.5 Alarm Menu

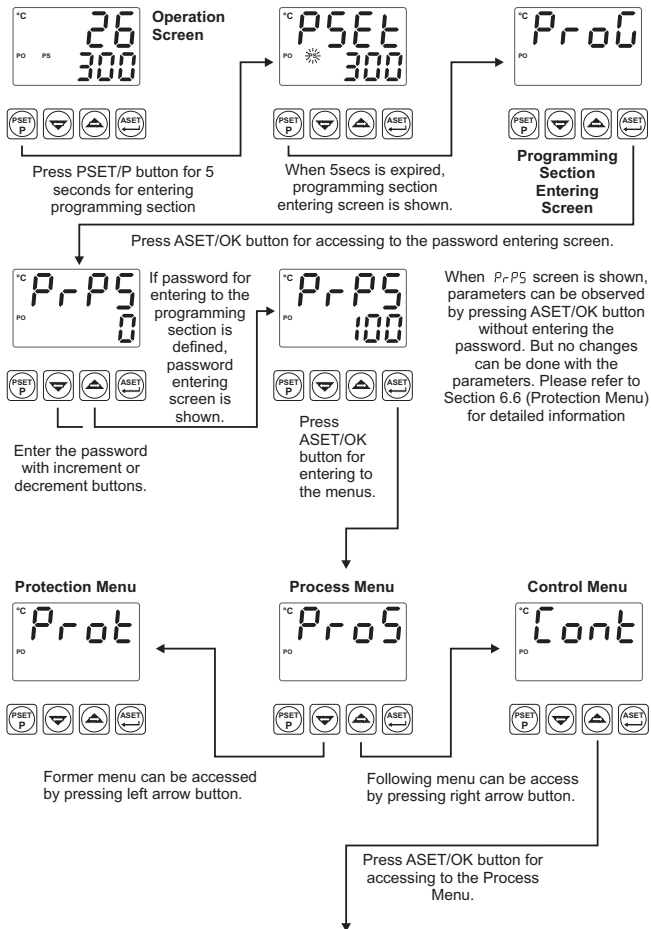

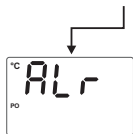

Alarm Menu



Press ASET/OK button to access to the alarm menu.

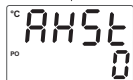

Alarm Hysteresis value

It can be adjusted from 0% of (AuPL-ALoL) to 50% of (AuPL-ALoL).



Press ASET/OK button for saving the changes and accessing to the following parameter.

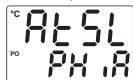

Alarm Type Selection

It can be adjusted to the values listed below:

PH.A : Process High Alarm

PLoA : Process Low Alarm

dH.A : Deviation High Alarm

dLoA : Deviation Low Alarm

dbnA : Deviation Band Alarm

drnA : Deviation Range Alarm

Please refer to Section 7.2 Alarm Types for detailed information



Press ASET/OK button for saving the changes and accessing to the following parameter.

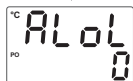

Alarm Set Low Limit Value

Minimum value of the alarm set is defined with this parameter. It changes according to the process type and scale. It can be adjusted from process set value low limit parameter *PLoL* to alarm set high limit parameter *AuPL* value.



Press ASET/OK button for saving the changes and accessing to the following parameter.

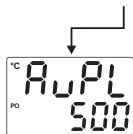

Alarm Set High Limit Value

Maximum value of alarm set is defined with this parameter. It can be adjusted from alarm set low limit parameter $ALOL$ to process set high limit parameter P_uPL . It changes according to process input type and scale.



Press ASET/OK button for saving the changes and accessing to the following parameter.



Alarm On Delay Time

It can be adjusted from 0 to 999 seconds with increment and decrement buttons.

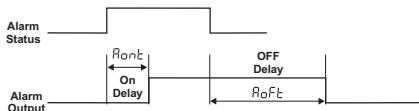

Press ASET/OK button for saving the changes and accessing to the following parameter.

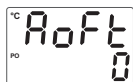

Alarm OFF Delay Time

It can be adjusted from 0 to 9998 seconds. When it is higher than 9998, $LECH$ is shown and alarm latching output is selected. To make the alarm latching output passive, decrement button must be pressed in main operation screen.



Press ASET/OK button for saving the changes and accessing to the following parameter.

Control Menu



Former menu can be accessed by pressing left arrow button.

Alarm Menu

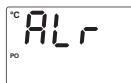

Press PSET/P for exiting menu list and turn to operation screen.

Protection Menu



Following menu can be access by pressing right arrow button.

Press ASET/OK button for accessing to the Process Menu.

6.6 Protection Menu

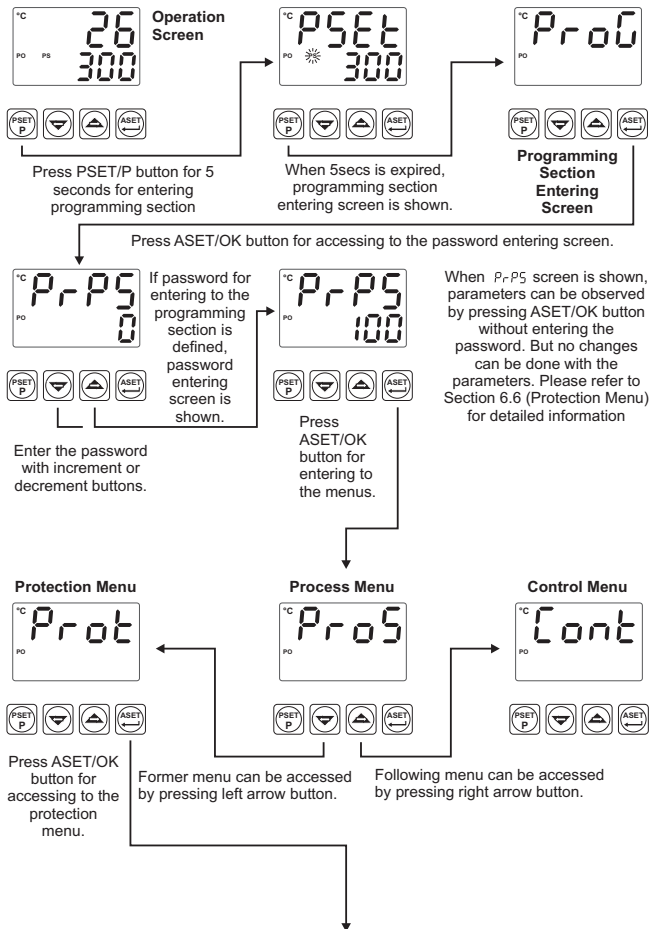

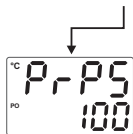

Programming Section Entering Password

It is used for accessing to the programming section. It can be adjusted from 0 to 9999.

If it is 0, programming section is accessed without entering the password.



If it is different from 0, in programming section entering password;

1- If user enters the password incorrect:

Device turns to main operation screen without being able to see the parameters

2- If user press the ASET/OK button without entering the password PrPs

for entering to the programming section (observation of the parameters): All menus and parameters except protection menu (Prot) can be observed but they can not be changed.

(Please refer to Section 8. Failure Messages in ESM-9920 Temperature Controller(4))

Press ASET/OK button for saving the parameter and exiting from protection menu parameters.

Alarm Menu

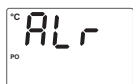

Former menu can be accessed by pressing left arrow button.

Protection Menu



Following menu can be access by pressing right arrow button.

Process Menu



Press PSET/P for exiting menu list and turn to operation screen.

Operation Screen



7. General Information

7.1 Tune Operation

Esm-XX20 devices use **Self Tune** (Step Response Tuning) method to automatically determine PID parameters.

Starting the Tune operation by the user

- Enter to the programming section
- Select the t_{unE} parameter in C_{ont} menu, YES and turn to main operation screen.
- Observe that t_{unE} is blinking in set display

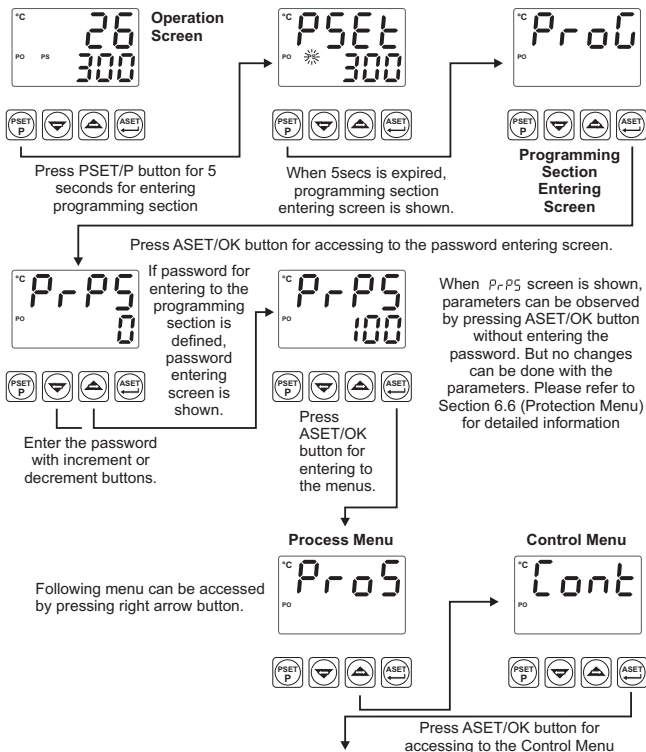

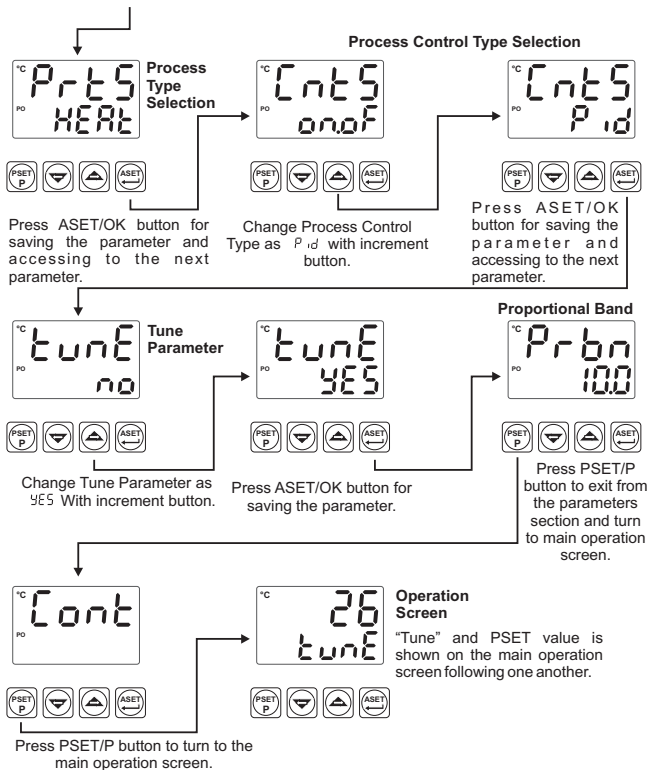

If **Self Tune** operation is finished without any problem, device saves new PID parameters to memory and runs. It changes `tune` parameter to `no`

Canceling **Self Tune** operation :

- 1- If sensor breaks ;
- 2- If **Self Tune** operation can not be completed in 8 hours ;
- 3- While **Self Tune** operation is running, if user changes process set value ;

Self Tune operation is canceled. Then device continues to run with former PID parameters without changing PID parameters.

If power is off while **Self Tune** operation continues, PID parameters and t_{unE} parameter are not changed. When power is off and then on, device starts to complete the **Self Tune** operation.

If heating function and PID control form is selected for the system;

If set value is greater than process value, process output becomes active till to the **Temperature + [(Set - Temperature) / 2]** value. When process value reaches to this value, process output reduces to 0% and it calculates the PID coefficients.

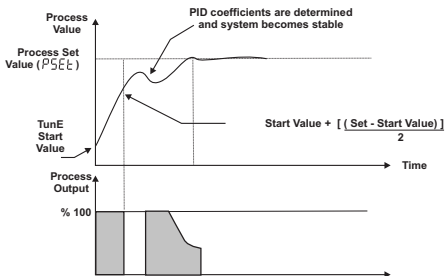

If cooling function and PID control form is selected for the system;

If set value is less than process value, process output becomes active till to the **Temperature - [(Temperature - Set) / 2]** value. When process value reaches to this value, process output is reduced to 0% and it starts to calculate PID coefficients.

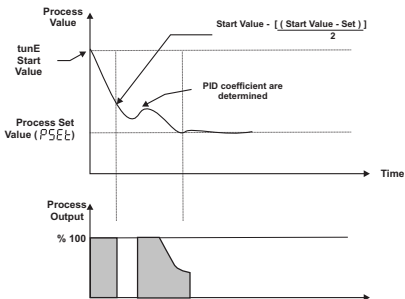

For starting Tune (Step Response Tuning) operation :

1- Control form must be P,PI,PD or PID.

2- For heating tune, Process Value must be 5% of full scale lower than process set value

For cooling tune, process value must be 5% of full scale higher than process set value.

3- If Process Set Value is changed while Tune operation continues, tune operation is canceled.

7.2 Alarm Types

Alarm types which are explained in Section 6.5 Alarm Types Selection parameter $AtSL$ are explained below:

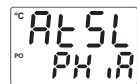

Process High Alarm

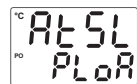
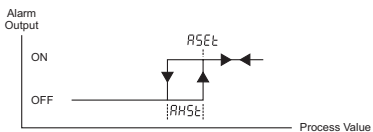

Process Low Alarm

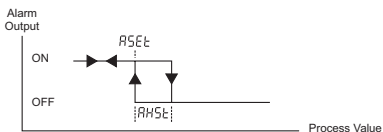

Deviation High Alarm

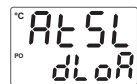
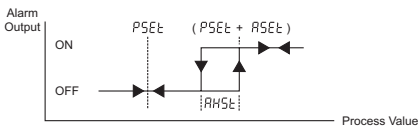

Deviation Low Alarm

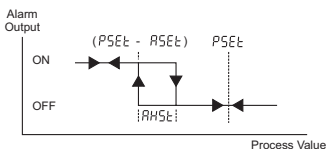



Deviation Band Alarm

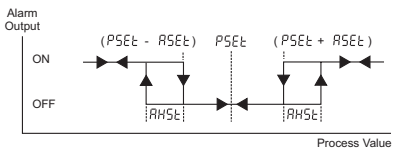

Deviation Range Alarm

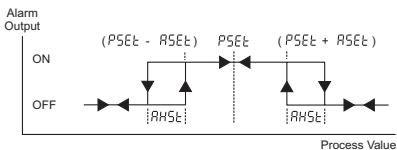

8. Failure Messages in ESM-9920 Temperature Controller



1- Sensor failure in analog inputs. Sensor connection is wrong or there is no sensor connection.

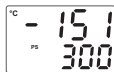

2- If value that is read from the analog input is lower than process set low limit parameter $PLoL$, value on the top display starts to blink like on the picture.



For this example in $Pro5$ menu

$P_{in5} = FEEC$; $unit = ^\circ C$; $PLoL = -150$ and $PuPL = 250$



Please refer to Section 6.3 for detailed information about the parameter



3- If value that is read from the analog input is higher than process set high limit parameter value $PuPL$, value on the top display starts to blink like on the picture.



For this example in $Pro5$ menu

$P_{in5} = FEEC$; $unit = ^\circ C$; $PLoL = -150$ and $PuPL = 250$



Please refer to Section 6.3 for detailed information about the parameter

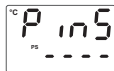

4- If programming section entering password is different from "0" and user accesses to the parameter by ASET/OK button without entering the password and wants to change a parameter, the warning message is shown on the bottom display as shown on the left. Device does not allow to do any changes without entering the password correctly.



5- If user does not do anything for 120 seconds while device is on programming section, device turns to operation screen.

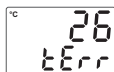
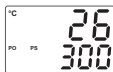

6- In programming section, when Tune operation is selected YES, if warning which is shown on the left blinks in operation screen for 10 seconds, it means that start conditions is not okay for Tune operation.



9. Specifications

Device Type	: Temperature Controller
Housing&Mounting	: 96mm x 96mm x 96mm 1/4 DIN 43700 plastic housing for panel mounting. Panel cut-out is 92x92mm.
Protection Class	: NEMA 4X (IP65 at front, IP20 at rear).
Weight	: Approximately 0.34 Kg.
Environmental Ratings	: Standard, indoor at an altitude of less than 2000 meters with none condensing humidity.
Storage/Operating Temperature	: -40 °C to +85 °C / 0 °C to +50 °C
Storage/Operating Humidity	: 90 % max. (None condensing)
Installation	: Fixed installation
Overvoltage Category	: II
Pollution Degree	: II, office or workplace, none conductive pollution
Operating Conditions	: Continuous
Supply Voltage and Power	: 230 V ~ (±15%) 50/60 Hz. 3VA 115 V ~ (±15%) 50/60 Hz. 3VA 24 V ~ (±15%) 50/60 Hz. 3VA 24 V ≈ (-15%;+10%) 50/60 Hz. 3VA
Process Inputs	: Universal input TC, RTD
Thermocouple input types	: Selectable by parameters J ,K ,R ,S ,T (IEC584.1)(ITS90)
Thermoresistance input type	: PT 100 (IEC751) (ITS90)
Accuracy	: ± 0,25% of full scale for Thermocouple and Thermoresistance
Cold Junction Compensation	: Automatically ± 0.1°C/1°C.
Line Compensation	: Maximum 10 Ω .
Sensor Break Protection	: Upscale
Sampling Cycle	: 3 samples per second
Input Filter	: 1.0 second
Control Forms	: Programmable ON / OFF, P, PI, PD or PID.
Relay Outputs	: 2 pieces.Resistive load 5A@250V ~ (Programmable control or alarm output) (Electrical Life : 100.000 Operation (Full Load))
Optional SSR Driver Output	: Max 12V--- ,10mA
Process Display	: 19 mm Red 4 digits LED display
Set Display	: 10.8 mm Green 4 digits LED display
LED Indicators	: PS (Process Set value), AS (Alarm Set value), PO (Process Output) , AO (Alarm Output) °C ve °F unit leds
Approvals	: GOST-R, CE